

LOWLINE Plus

Schneider
my swiss mirror

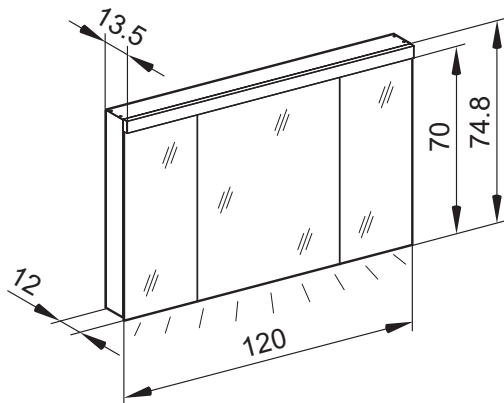

LED
4000 K

LED
Optional
3000 K



IP 44

Artikel 1. Ausgabe
Article **621 298** 1. Edition **09-2019**
Articolo 1. Edizione

Art. No **172.121** Mut.

Spiegelschrank LOP 120/3/LED
Armoire-miroir LOP 120/3/LED
Armadio specchio LOP 120/3/LED

W. Schneider+Co AG, CH-8135 Langnau a.A.
www.wschneider.com © 2019

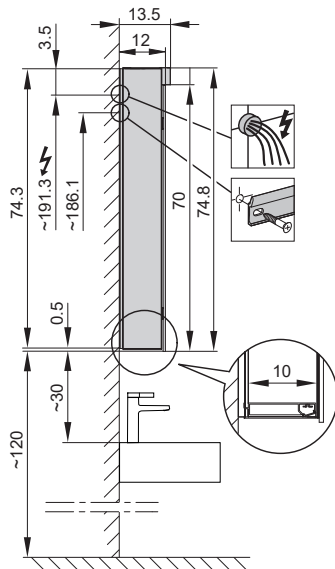

Aufputz-Montage **AP**
Pose en applique
Surface mounting

LOP/LED/AP	A	B
50..	35	7.25
60..	35	12.25
70..	55	7.5
80..	55	12.25
90..	65	12.25
100..	65	17.25
120..	95	12.25
130..	95	17.25
150..	125	12.5

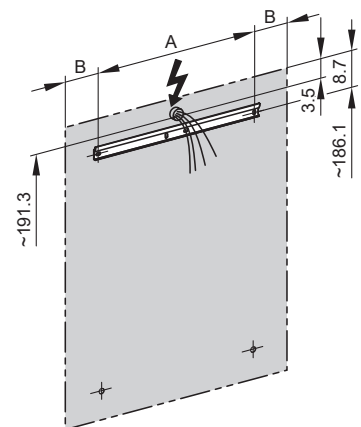

Montageschiene
Rail de suspension
Guida di montaggio

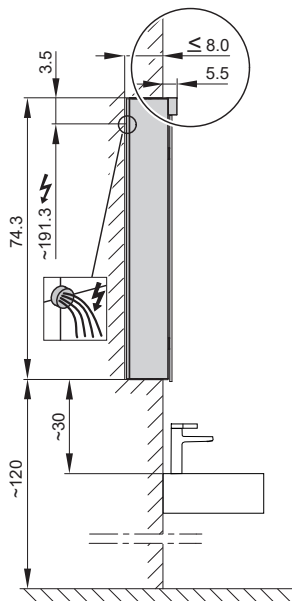

Unterputz-Montage **UP**
Pose en encastrement
Recessed mounting

LOP/LED/UP	A
50..	49.5
60..	59.5
70..	69.5
80..	79.5
90..	89.5
100..	99.5
120..	119.5
130..	129.5
150..	149.5

UP-Montage: Nischengröße X x Y und Befestigung Spiegelschrank sind bauseits zu bestimmen.

Montage encastré: la taille de la niche X x Y et la fixation de l'armoire-miroir doivent être déterminées par le client.

Flush mounting: the recess dimensions X by Y and the fixing system for the mirrored cabinet will need to be determined on site.

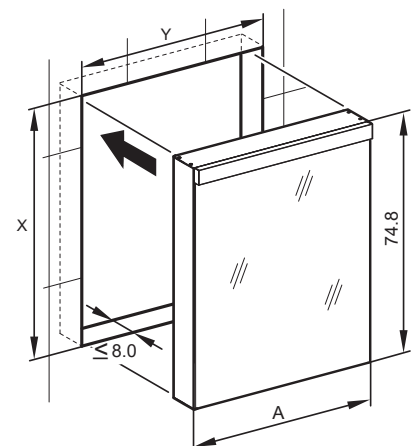

Die Massangaben in cm verstehen sich unter dem Vorbehalt der Werkstoleranzen, eventuell späterer Änderungen sowie weiterer Montagemöglichkeiten. Die Haftung für Folgen fehlerhafter oder unvollständiger Massangaben ist ausgeschlossen. (Art. 100 OR).

Les dimensions en cm s'entendent sous réserve des tolérances d'usine, d'éventuelles modifications ultérieures, de même que de nouvelles possibilités de montage. La responsabilité ne peut être engagée en cas de cotes manquantes ou erronées (CD art. 100).

Le dimensioni in cm s'intendono fatte salve le tolleranze di fabbricazione, le eventuali modifiche successive e le ulteriori alternative di montaggio. Si declina qualsiasi responsabilità per le conseguenze legate a dimensioni errate o incomplete (art. 100 CO).