

PREMIUM Line Ultimate HCL

Schneider
my ultimate mirror experience

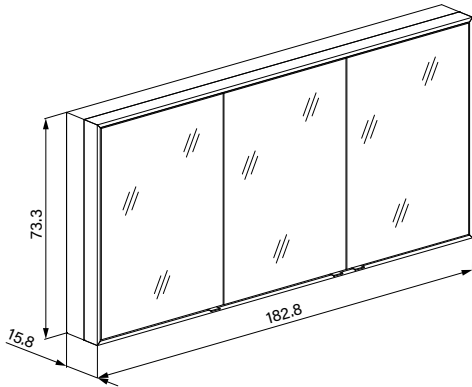

LED
2000 -
6500 K



IP 44

Artikel 1. Ausgabe
Article **621 494** 1. Edition **04-2020**
Articolo 1. Edizione

Art. No. **182.180.01.50** Mut.

Spiegelschrank PLU1 180/3/GT/HCL
Armoire-miroir PLU1 180/3/GT/HCL
Armadio specchio PLU1 180/3/GT/HCL

W. Schneider+Co AG, CH-8135 Langnau a.A.
www.wschneider.com © 2020

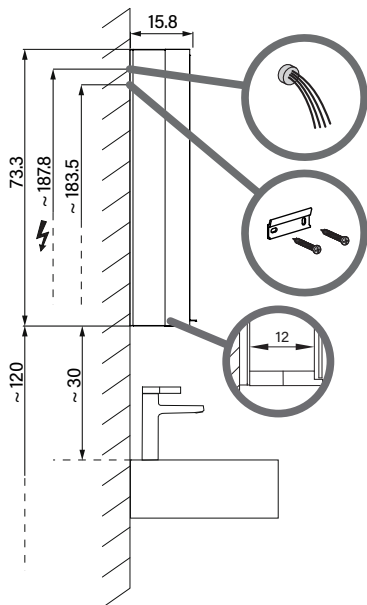

Aufputz-Montage **AP**
Pose en applique
Surface mounting

PLU1/HCL/AP	A
50..	19
60..	29
70..	39
80..	49
90..	59
100..	69
120..	89
130..	99
150..	119
180..	149

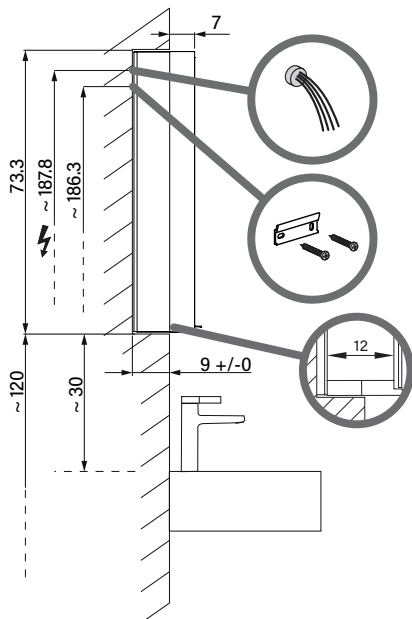
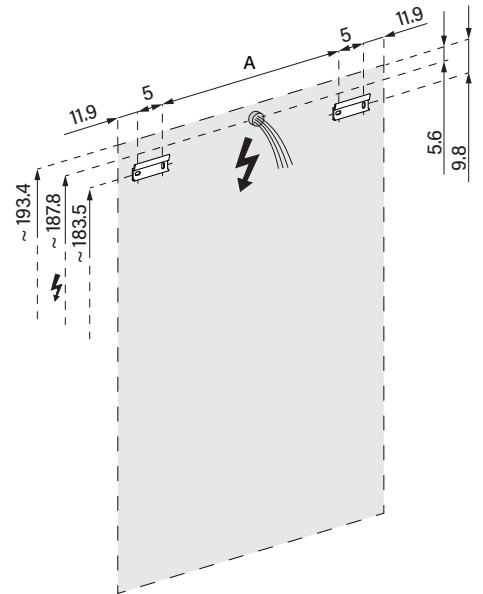

Unterputz-Montage **UP**
Pose en encastrement
Recessed mounting

PLU1/HCL/UP	A	B +/- 0.1
50..	34.6	53
60..	44.6	63
70..	54.6	73
80..	64.6	83
90..	74.6	93
100..	84.6	103
120..	104.6	123
130..	114.6	133
150..	134.6	153
180..	164.6	183

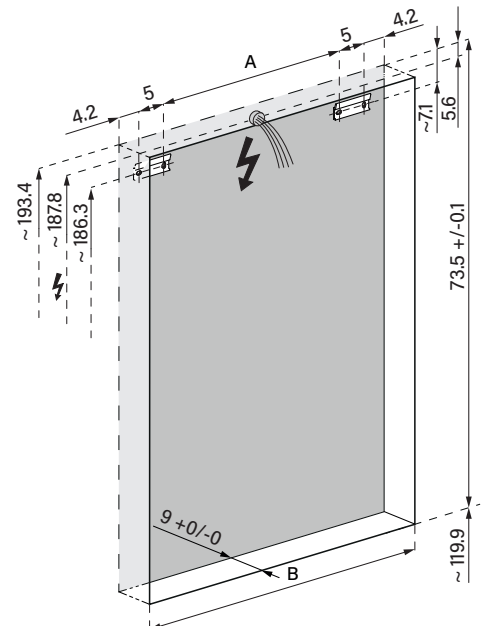

Die Massangaben in cm verstehen sich unter dem Vorbehalt der Werkstoleranzen, eventuell späterer Änderungen sowie weiterer Montagemöglichkeiten. Die Haftung für Folgen fehlerhafter oder unvollständiger Massangaben ist ausgeschlossen. (Art. 100 OR).

Les dimensions en cm s'entendent sous réserve des tolérances d'usine, d'éventuelles modifications ultérieures, de même que de nouvelles possibilités de montage. La responsabilité ne peut être engagée en cas de cotes manquantes ou erronées (CD art. 100).

Le dimensioni in cm s'intendono fatte salve le tolleranze di fabbricazione, le eventuali modifiche successive e le ulteriori alternative di montaggio. Si declina qualsiasi responsabilità per le conseguenze legate a dimensioni errate o incomplete (art. 100 CO).