

# ADVANCED Line Ultimate TW

**Schneider**  
my ultimate mirror experience

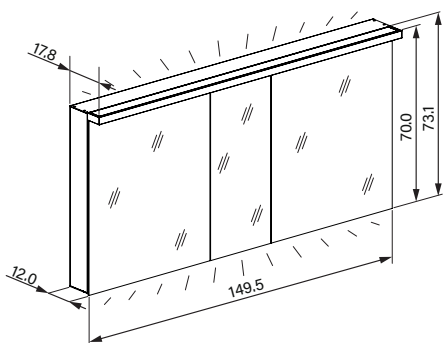

**LED**  
2000 -  
6500 K



**IP 44**

Artikel  
Article **622 026**  
Articolo  
1. Ausgabe  
1. Edition  
1. Edizione **01-2022**

Art. No. **188.150** Mut.

**Spiegelschrank ALU1 150/3/TW**  
**Armoire-miroir ALU1 150/3/TW**  
**Armadio specchio ALU1 150/3/TW**

W. Schneider+Co AG, CH-8135 Langnau a.A.  
www.wschneider.com © 2021

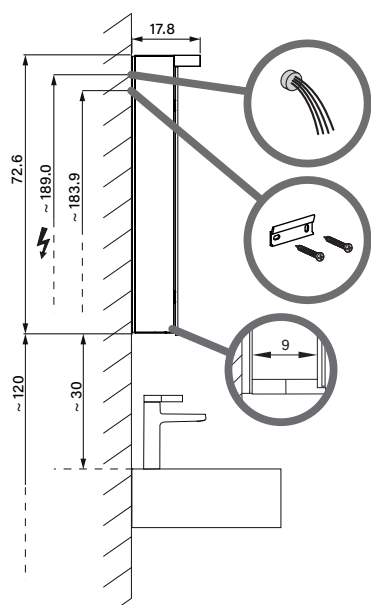

**Aufputz-Montage**  
Pose en applique  
Surface mounting

ALU1/TW/AP	A
50..	35
60..	35
70..	55
80..	55
90..	65
100..	65
120..	95
130..	95
140..	95
150..	125
180..	125

**AP**

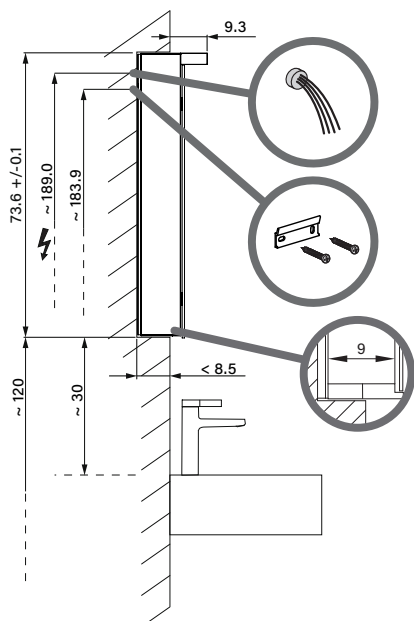
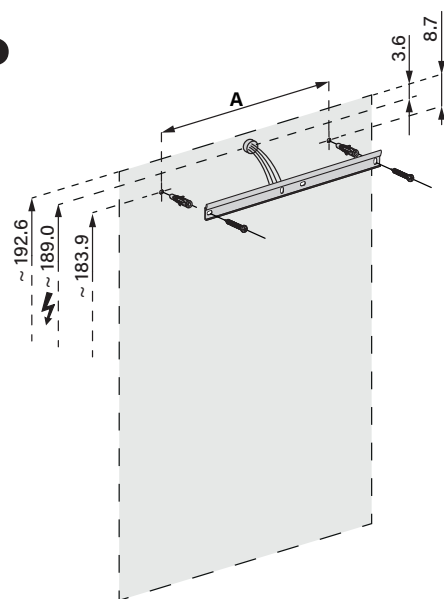

**Unterputz-Montage**  
Pose en encastrement  
Recessed mounting

ALU1/TW/UP	A	B
50..	35	50.0
60..	35	60.0
70..	55	70.0
80..	55	80.0
90..	65	90.0
100..	65	100.0
120..	95	120.0
130..	95	130.0
140..	95	140.0
150..	125	150.0
180..	125	180.0

**UP**

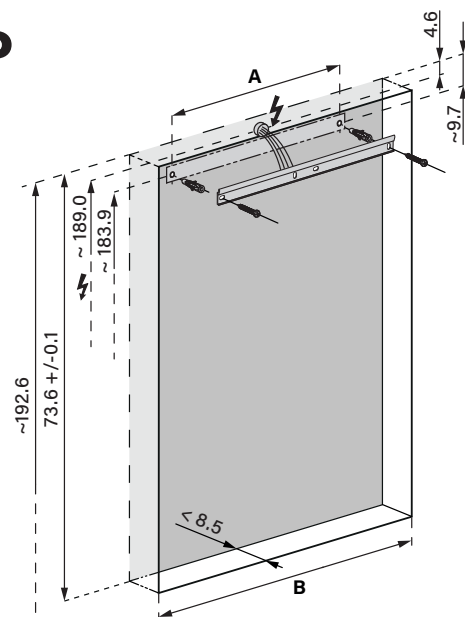

Die Massangaben in cm verstehen sich unter dem Vorbehalt der Werkstoleranzen, eventuell späterer Änderungen sowie weiterer Montagemöglichkeiten. Die Haftung für Folgen fehlerhafter oder unvollständiger Massangaben ist ausgeschlossen. (Art. 100 OR).

Les dimensions en cm s'entendent sous réserve des tolérances d'usine, d'éventuelles modifications ultérieures, de même que de nouvelles possibilités de montage. La responsabilité ne peut être engagée en cas de cotes manquantes ou erronées (CD art. 100).

Le dimensioni in cm s'intendono fatte salve le tolleranze di fabbricazione, le eventuali modifiche successive e le ulteriori alternative di montaggio. Si declina qualsiasi responsabilità per le conseguenze legate a dimensioni errate o incomplete (art. 100 CO).