

OBJECT Line Comfort LED

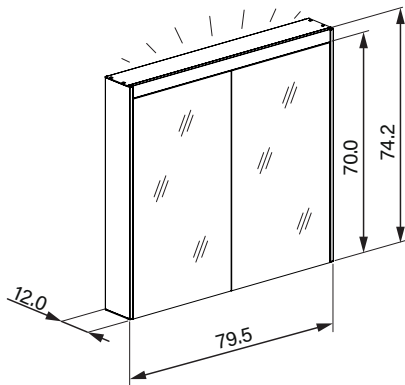

LED
4000 K

LED
3000 K



IP 44

Schneider

my ultimate mirror experience

Artikel 1. Ausgabe
Article **621 932** 1. Edition **01-2023**
Articolo 1. Edizione

Art. No **204.080** Mut.

Spiegelschrank OLC1 80/2/LED
Armoire-miroir OLC1 80/2/LED
Armadio specchio OLC1 80/2/LED

W. Schneider+Co AG, CH-8890 Flums
www.wschneider.com © 2023

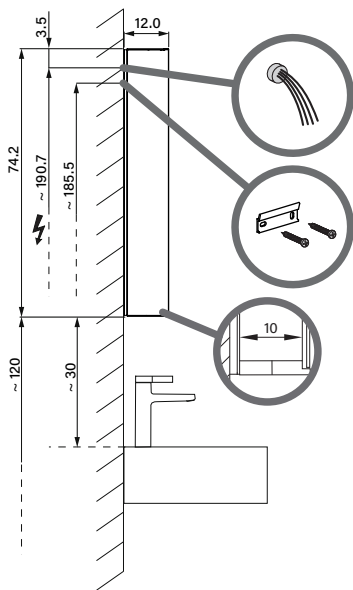

Aufputz-Montage **AP**
Pose en applique
Surface mounting

OLC1/LED/AP	A
50..	35
60..	35
70..	55
80..	55
90..	65
100..	65
120..	95
130..	95
150..	125

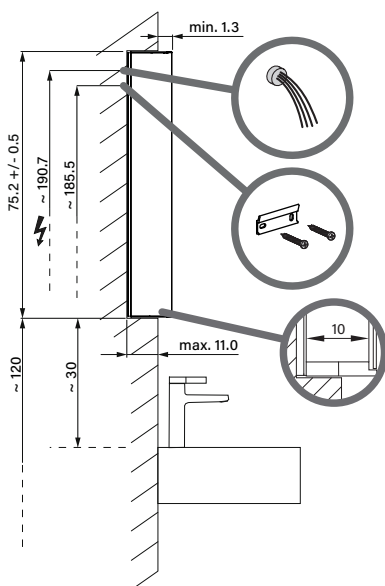
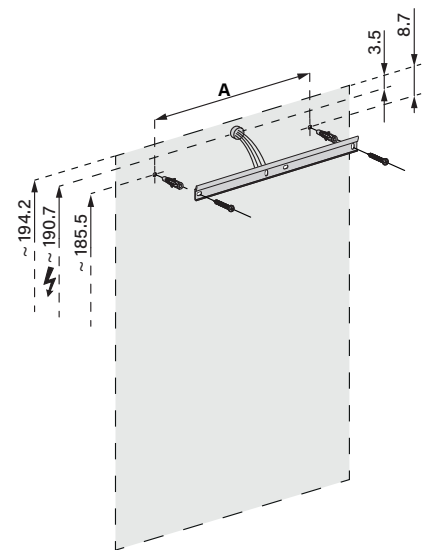

Unterputz-Montage **UP**
Pose en encastrement
Recessed mounting

OLC1/LED/UP	A	B
50..	35	50.0
60..	35	60.0
70..	55	70.0
80..	55	80.0
90..	65	90.0
100..	65	100.0
120..	95	120.0
130..	95	130.0
150..	125	150.0

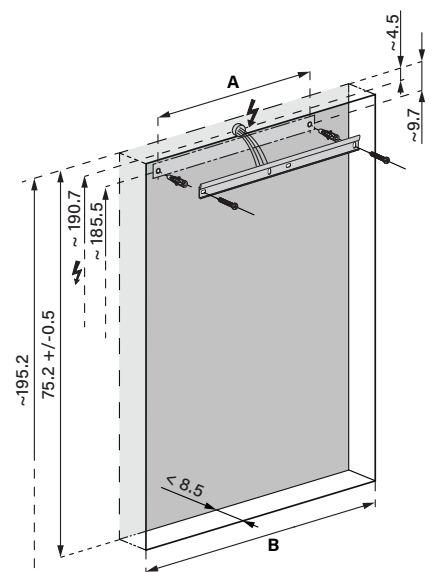

Die Massangaben in cm verstehen sich unter dem Vorbehalt der Werkstoleranzen, eventuell späterer Änderungen sowie weiterer Montagemöglichkeiten. Die Haftung für Folgen fehlerhafter oder unvollständiger Massangaben ist ausgeschlossen. (Art. 100 OR).

Les dimensions en cm s'entendent sous réserve des tolérances d'usine, d'éventuelles modifications ultérieures, de même que de nouvelles possibilités de montage. La responsabilité ne peut être engagée en cas de cotes manquantes ou erronées (CD art. 100).

Le dimensioni in cm s'intendono fatte salve le tolleranze di fabbricazione, le eventuali modifiche successive e le ulteriori alternative di montaggio. Si declina qualsiasi responsabilità per le conseguenze legate a dimensioni errate o incomplete (art. 100 CO).