

ADVANCED Line Superior HCL

Schneider
my ultimate mirror experience

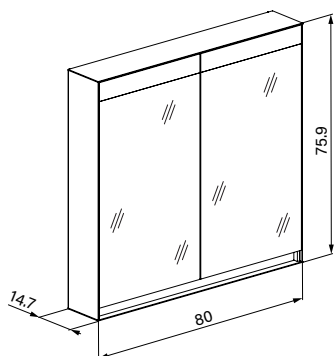

LED
2000 -
6500 K



IP 44

Artikel 1. Ausgabe
Article **621 851** 1. Edition **04-2020**
Articolo 1. Edizione

Art. No. **180.080.01.04** Mut.

Spiegelschrank ALS1 80/2/HCL
Armoire-miroir ALS1 80/2/HCL
Armadio specchio ALS1 80/2/HCL

W. Schneider+Co AG, CH-8135 Langnau a.A.
www.wschneider.com © 2020

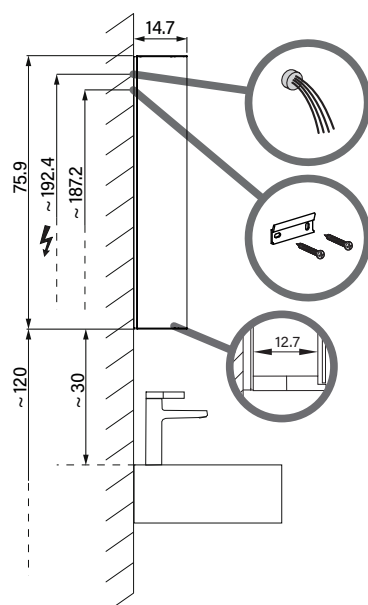

Aufputz-Montage **AP**
Pose en applique
Surface mounting

ALS1/HCL/AP	X
50..	35
60..	35
80..	55
90..	65
100..	65
120..	95
130..	95
140..	95
150..	125
180..	125

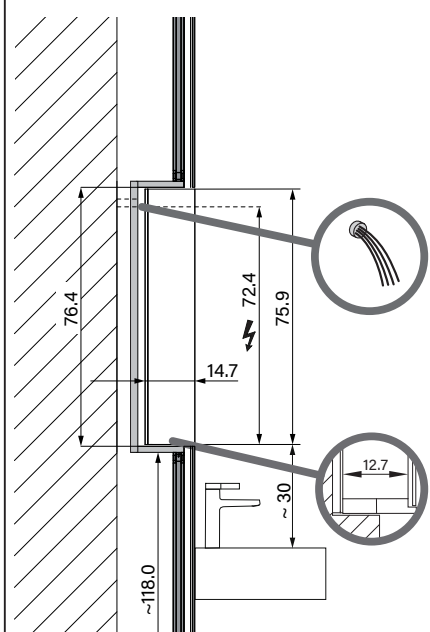
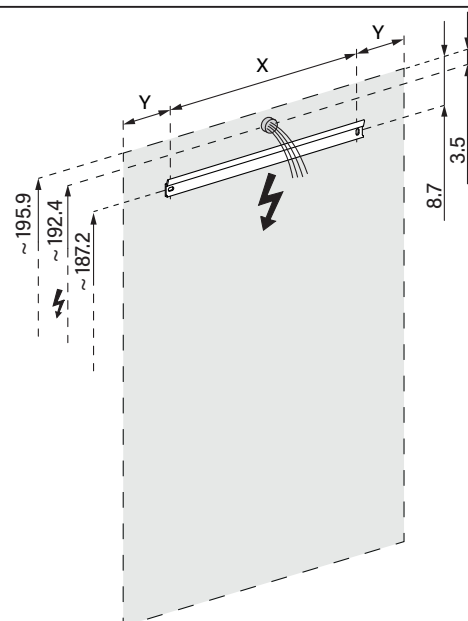

Unterputz-Montage mit
UP-Einbaurahmen
Pose en encastrement avec
cadre de montage
Recessed mounting with
installation box

ALS1/HCL/UP	A
50..	50.0
60..	60.0
80..	80.0
90..	90.0
100..	100.0
120..	120.0
130..	130.0
140..	140.0
150..	150.0
180..	180.0

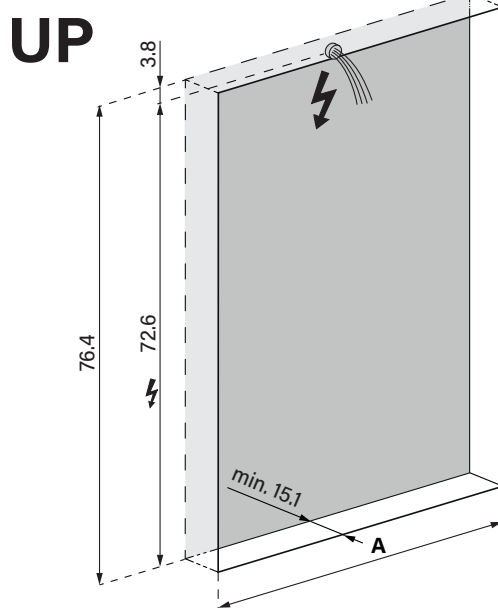

Die Massangaben in cm verstehen sich unter dem Vorbehalt der Werkstoleranzen, eventuell späterer Änderungen sowie weiterer Montagemöglichkeiten. Die Haftung für Folgen fehlerhafter oder unvollständiger Massangaben ist ausgeschlossen. (Art. 100 OR).

Les dimensions en cm s'entendent sous réserve des tolérances d'usine, d'éventuelles modifications ultérieures, de même que de nouvelles possibilités de montage. La responsabilité ne peut être engagée en cas de cotes manquantes ou erronées (CD art. 100).

Le dimensioni in cm s'intendono fatte salve le tolleranze di fabbricazione, le eventuali modifiche successive e le ulteriori alternative di montaggio. Si declina qualsiasi responsabilità per le conseguenze legate a dimensioni errate o incomplete (art. 100 CO).